

1

Kit 145001

TOYOTA Prius, 5-dr Hatchback, 09-15 / *10-15

*North America



ISO 11154-E

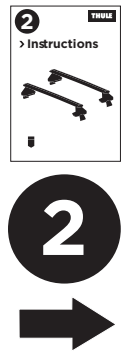
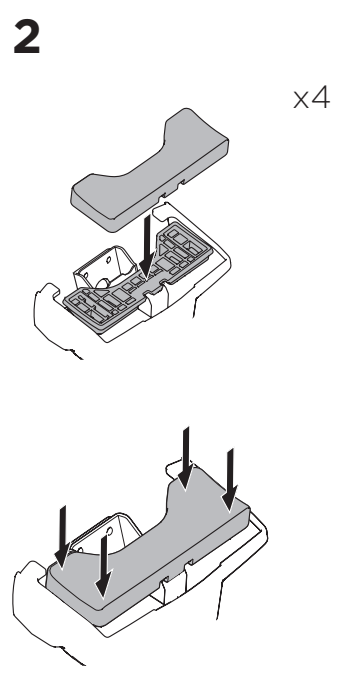
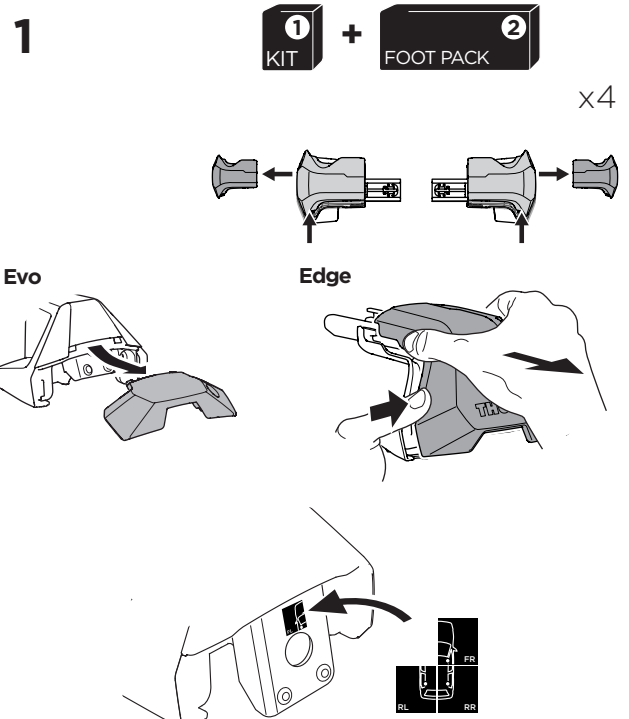
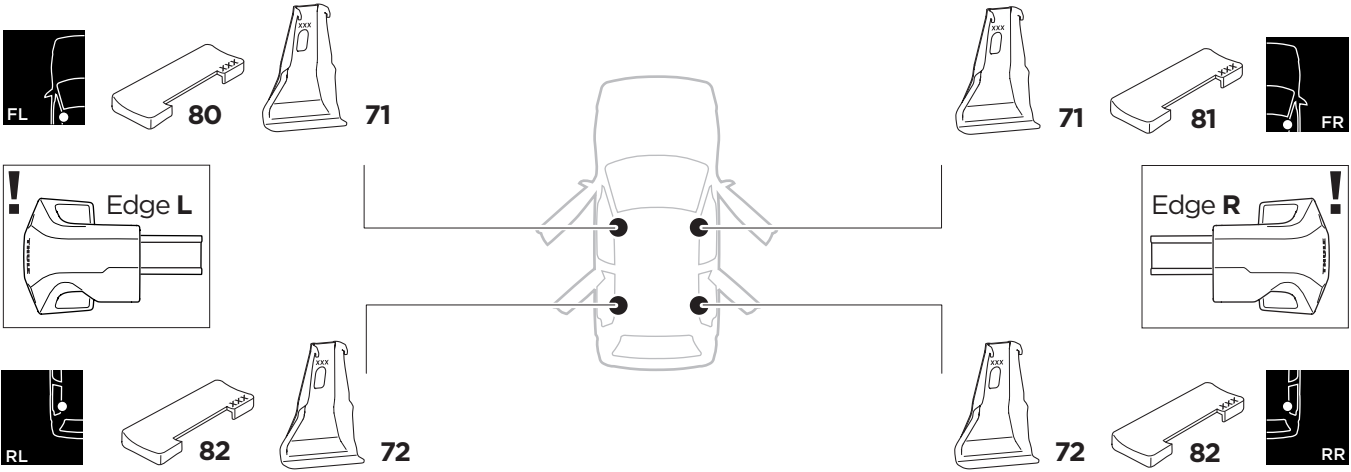
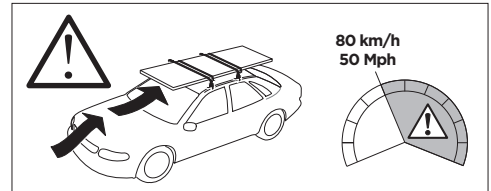
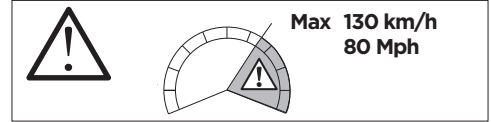
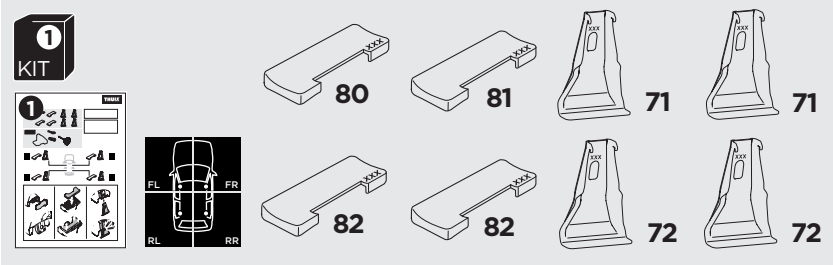



THULE WingBar Evo	THULE WingBar Edge	THULE WingBar	THULE SquareBar Evo	Evo X (scale)	Edge X (scale)
TOYOTA Prius, 5-dr Hatchback, 09-15 / *10-15				40	Q
THULE ProBar Evo	THULE SlideBar Evo				X (mm/inch)
TOYOTA Prius, 5-dr Hatchback, 09-15 / *10-15				1051 mm / 41 3/8"	

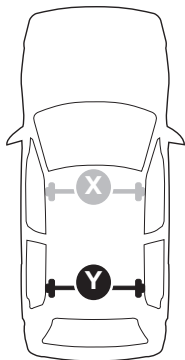

THULE WingBar Evo	THULE WingBar Edge	THULE WingBar	THULE SquareBar Evo	Evo Y (scale)	Edge Y (scale)
TOYOTA Prius, 5-dr Hatchback, 09-15 / *10-15				35,5	H
THULE ProBar Evo	THULE SlideBar Evo				Y (mm/inch)
TOYOTA Prius, 5-dr Hatchback, 09-15 / *10-15				1006 mm / 39 5/8"	

	W (mm/inch)	Z (mm/inch)
TOYOTA Prius, 5-dr Hatchback, 09-15 / *10-15	720 mm / 27 1/2"	250 mm / 9 7/8"

